

THANK YOU FOR PURCHASING THIS QUALITY PRODUCT.
BE SURE TO CHECK ALL PACKING MATERIAL CAREFULLY FOR SMALL PARTS THAT MAY HAVE COME LOOSE INSIDE.
THE CARTON DURING TRANSIT.

STEP 1

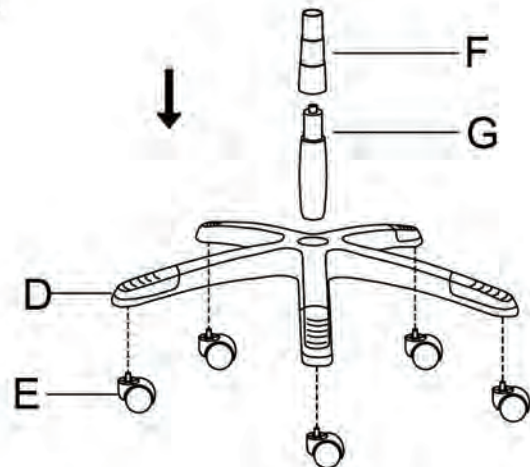

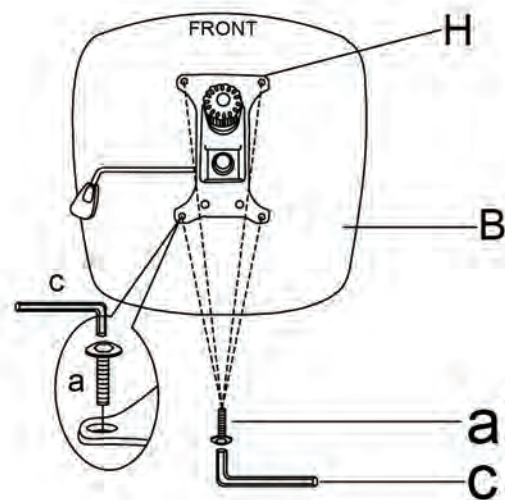



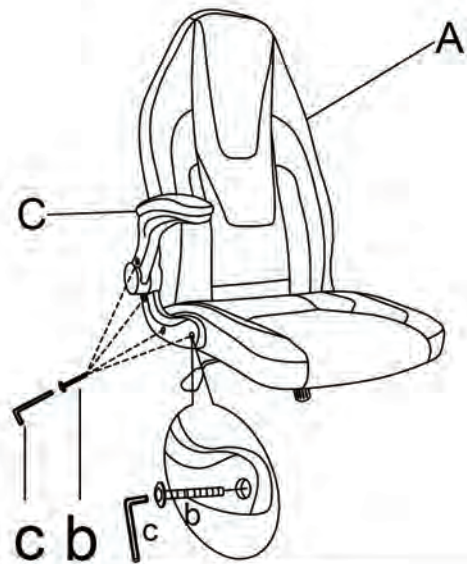

STEP 2







STEP 3

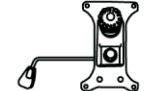

PART LIST

NO	DESC	SIZE (MM)	SKETCH	QTY
A	BACK	760X510 X100		1 PC
B	SEAT	520X520 X90		1 PC
C	ARMREST	405X320 X80		1 SET
D	STARBASE	R350X100		1 PC
E	CASTORS	80X60 X55		5 PCS
F	GASLIFT COVER	R30XL100		1 PC
G	GASLIFT	R25XL260		1 PC
H	SWIVEL TRAY	350X280 X110		1 PC

HARDWARE LIST

NO	DESC	SIZE (MM)	SKETCH	QTY
a	SCREW	M6X20		4 PCS
b	SCREW	M6X25		8 PCS
C	SPANNER	M6		1 PC
d	SCREW COVER	R9X8		8 PCS

MADE IN CHINA

THANK YOU FOR PURCHASING THIS QUALITY PRODUCT.
BE SURE TO CHECK ALL PACKING MATERIAL CAREFULLY FOR SMALL PARTS THAT MAY HAVE COME LOOSE INSIDE.
THE CARTON DURING TRANSIT.

STEP 4

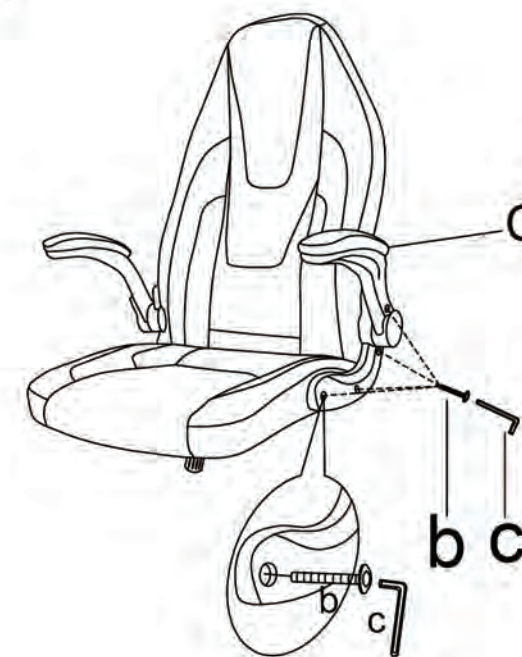

STEP 5

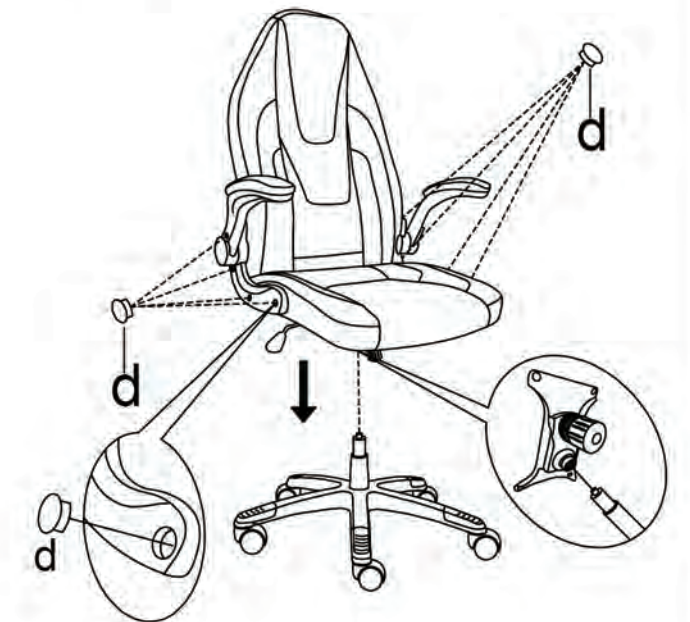

FINISH



MADE IN CHINA